

# High Temperature Deep Cycle GEL Battery

# HTL12-200

<b>12V</b> Voltage	<b>200Ah</b> Capacity	<b>Gel</b> Technology	<b>Deep</b> Cycle
-----------------------	--------------------------	--------------------------	----------------------



The HTL deep cycle gel battery adopts the advanced developed nano gel electrolyte with super-C additive plus heavy duty plates design inside. It has a longer service life even deep cycle discharge use and can provide optimum and reliable service under extreme condition such as high temperature and frequent power failure, thus it is highly suited for tropical area in outdoor applications such as Telecom BTS stations and Off-grid PV system.

### GENERAL FEATURES

- Able to operate at 40-60°C
- Integrated design to ensure the best uniformity and reliability
- Longer life and higher stability under high temp. environment (no air-con needed)
- Super-C additives: Deep discharge recovery capability, 1600cycles @50%DOD

### APPLICATIONS

- BTS Stations
- Solar & Wind energy system
- UPS system
- Telecom systems
- Wheel chair, Golf cart

### COMPLIED STANDARDS

IEC 60896-21/22    JIS C8704  
IEC61427            BS6290 part4  
GB/T 19638        CE/ISO

### DIMENSIONS & WEIGHT

Length(mm)	532±1
Width(mm)	206±1
Height(mm)	215±1
Total Height(mm)	219±1
Weight(kg)	58.6±3%

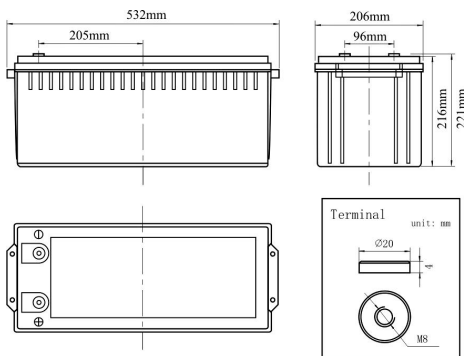

### TECHNICAL SPECIFICATIONS

Nominal Voltage		12V (6 cells per unit)
Design Floating Life @25°C		20 Years
Nominal Capacity @25°C (20 hour rate@10.0A,10.8V)		200Ah
Capacity @25°C	10hour rate (18.0A,10.8V)	180Ah
	5 hour rate (31.8A,10.5V)	159Ah
	1 hour rate (115.5A,9.6V)	115.5Ah
Internal Resistance	Full Charged Battery@25°C	≤3.0mΩ
Ambient Temperature	Discharge	-25°C~60°C
	Charge	-25°C~60°C
	Storage	-25°C~60°C
Max.Discharge Current@25°C		1200A(5s)
Capacity affected by Temperature (10 hour)	40°C	108%
	25°C	100%
	0°C	90%
	-15°C	70%
Self-Discharge@25°C per Month		3%
Charge (Constant Voltage) @25°C	Standby Use	Initial Charging Current Less than 45.0A Voltage 13.6-13.8V
	Cycle Use	Initial Charging Current Less than 45.0A Voltage 14.4-14.9V

### BATTERY DISCHARGE TABEL

#### Discharge Constant Current per Cell (Amperes at 25°C)

F.V/Time	15min	30min	45min	1h	2h	3h	5h	8h	10h	20h	100h
1.60V	312.4	185.9	132.0	115.5	70.5	49.5	33.7	22.2	19.8	10.8	2.40
1.65V	306.7	182.5	129.6	113.4	69.2	48.6	33.0	21.8	19.4	10.6	2.35
1.70V	301.0	179.1	127.2	111.3	67.9	47.7	32.4	21.4	19.1	10.4	2.31
1.75V	295.4	175.8	124.8	109.2	66.7	46.8	31.8	21.0	18.7	10.2	2.26
1.80V	284.0	169.0	120.0	105.0	64.1	45.0	30.6	20.2	18.0	10.0	2.22

#### Discharge Constant Power per Cell (Watts at 25°C)

F.V/Time	15min	30min	45min	1h	2h	3h	5h	8h	10h	20h	100h
1.60V	535.5	357.9	254.1	222.3	135.7	95.3	64.8	42.8	38.1	20.8	4.62
1.65V	526.5	351.4	249.5	218.3	133.3	93.6	63.6	42.0	37.4	20.4	4.53
1.70V	517.5	344.8	244.9	214.3	130.8	91.8	62.4	41.2	36.7	20.0	4.44
1.75V	508.5	338.3	240.2	210.2	128.3	90.1	61.3	40.4	36.0	19.6	4.36
1.80V	490.5	325.3	231.0	202.1	123.4	86.6	58.9	38.9	34.7	19.3	4.27

**Note** The above data are average values, and can be obtained within 3 charge/discharge cycles. These are not minimum values. Cell and battery designs/specifications are subject to modification without notice. Contact **CSPOWER** for the latest information.

# High Temperature Deep Cycle GEL Battery

# HTL12-200

## PERFORMANCE CHARACTERISTICS

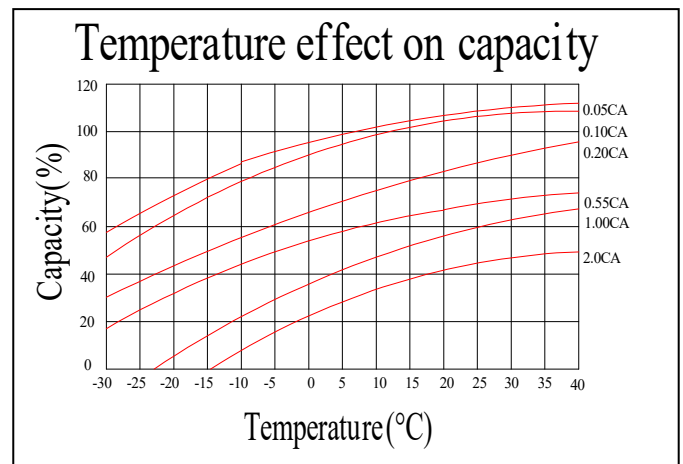
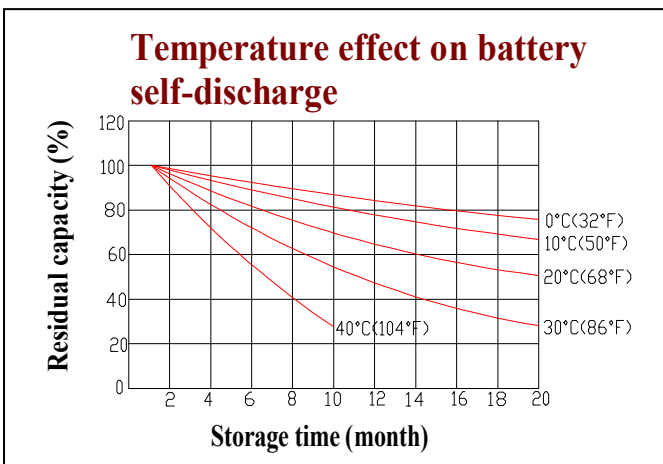
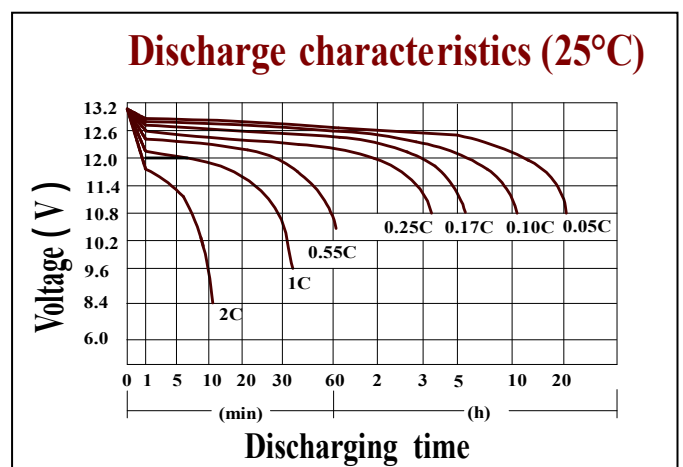
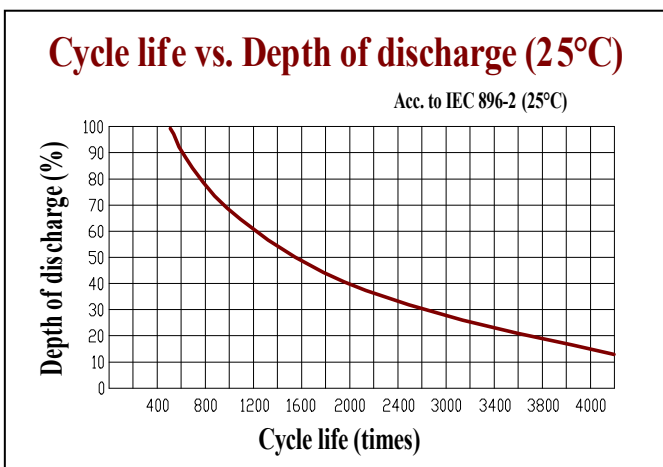
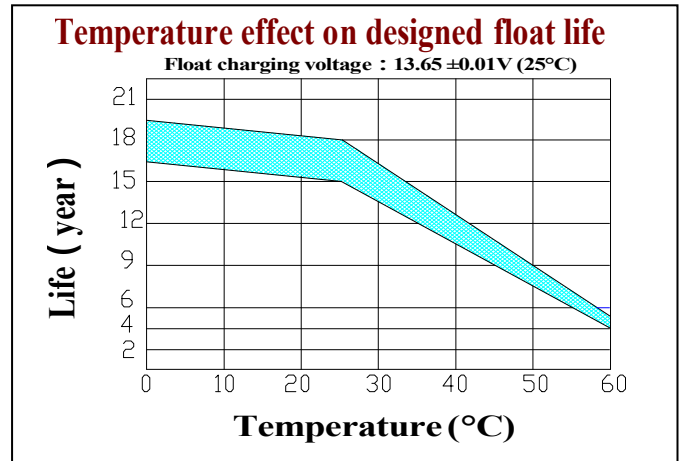
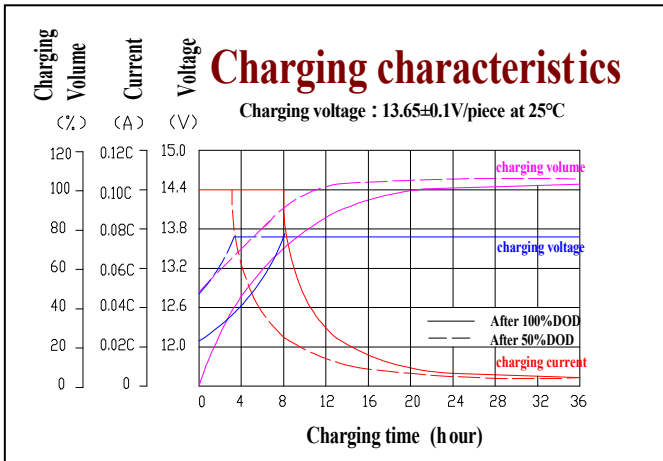

## BATTERY CONSTRUCTION

Component	Positive plate	Negative plate	Container & Cover	Safety valve	Terminal	Separator	Electrolyte	Pillar seal
Features	Thick high Sn low Ca grid with special paste	Balanced Pb-Ca grid for improved recombination efficiency	Fire resistant ABS (UL94-V0 optional)	Flame Si-Rubber and aging resistance	Female Copper Insert M8	Advanced PVC /AGM separator for high pressure cell design	Silicon Gel imported from Germany	Two layers epoxy resin seal

**Shenzhen CSPower Battery Technology Co.,Ltd.**

Add: Building B, Huafeng Technology Park, Baoan, Shenzhen, China.

Tel: +86-755-29123661 Email: sales@csagmbattery.com



[HTTP://WWW.CSAGMBATTERY.COM](http://www.csagmbattery.com)