

Photovoltaic Module Installation Manual of TONGWEI CO.,LTD



This manual applies to Modules types:

	With ½ cut of 182 mono c-Si cell	With ½ cut of 210*210 mono c-Si cell	With ½ cut of 182.2*191.6 mono c-Si cell	With ½ cut of 182*210 mono c-Si cell
Monofacial Module	TWMPD-78HS	TWMPF-66HS	TWMNG-72HS	TWMNH-66HS
	TWMPD-72HS	TWMPF-60HS		
	TWMPD-66HS	TWMPF-54HS		
	TWMPD-60HS	TWMPF-55HS		
	TWMPD-54HS	TWMPF-50HS		
	TWMPD-54HB			
	TWMND-78HS			
	TWMND-72HS			
	TWMND-66HS			
	TWMND-60HS			
	TWMND-54HS			
	TWMND-54HB			
Bifacial Module	TWMPD-78HD	TWMPF-66HD	TWMNG-72HD	TWMNH-66HD
	TWMPD-72HD	TWMPF-60HD	TWMNG-54HD	TWMNH-48HD
	TWMPD-66HD	TWMPF-55HD	TWMNG-54HC	TWMNH-48HC
	TWMPD-60HD	TWMPF-54HD		
	TWMND-78HD	TWMPF-50HD		
	TWMND-72HD	TWMHF-66HD		
	TWMND-66HD	TWMHF-60HD		
	TWMND-60HD			



➤ Meaning of crossed-out wheeled dustbin: Do not dispose of electrical appliances as unsorted municipal waste, use separate collection facilities. Contact your local government for information regarding the collection systems available.

➤ If electrical appliances are disposed of in landfills or dumps, hazardous substances can leak into the groundwater and get into the food chain, damaging your health and well-being. When replacing old appliances with new ones, the retailer is legally obligated to take back your old appliance for disposals at least free of charge.

Contents

1	01 Purpose of this Manual	
<hr/>		
1	02 Disclaimer	
<hr/>		
1	03 Safety & Transport	
<hr/>		
	3.1	General rules
	3.2	Electrical performance safety
	3.3	Package labeling instructions
	3.4	Unloading, transportation, storage
	3.5	Unpacking description
6	04 Mechanical Installation	
<hr/>		
	4.1	Location selection
	4.2	Installation requirements
	4.3	Installation method
12	05 Electrical Installation	
<hr/>		
	5.1	General installation
	5.2	PV module layout and wiring selection instructions
14	06 Grounding	
<hr/>		
	6.1	Grounding by cable
	6.2	Grounding by lugs
15	07 Bypass Diodes and Block Diodes	
<hr/>		
15	08 Maintenance	
<hr/>		

01 PURPOSE OF THIS MANUAL

- This manual applies exclusively to the solar photovoltaic module (here in after referred to as Module) of TONGWEI Co., Ltd. (here in after referred to as TW). The contents of this manual involve the installation methods, operation safety and maintenance information of TW's Modules.
- Modules must be installed by professionals. Please read this manual carefully before installation. The installers must follow all the rules in this manual strictly as well as local requirements and regulations by law or authorized organizations.
- Before installing, the installer must be familiar with their mechanical and electrical requirements. Please keep this manual in a safe place for future reference (care and maintenance) and in case of sale or disposal of the Modules.

02 DISCLAIMER

- TW shall not be responsible for any loss arising from the installation, operation, use or maintenance of the Modules which is not complying with the guidance of this manual, including breakdown or damage of the Modules or any other expenses incurred.
- Any customer shall not get any patent or authorization of the patent when using the Modules, expressed or implied. Any infringement of patents or other rights of the third party, which may result from the use of the Module, is not within the responsibility scope of TW. The information in this manual is based on TW's knowledge and experience and is believed to be reliable, but such information including product specification (without limitation) and relevant suggestions do not constitute a warranty, expressed or implied.
- TW reserves the rights to change the manual, the Modules, the specifications or any other information of the Modules without prior notice.

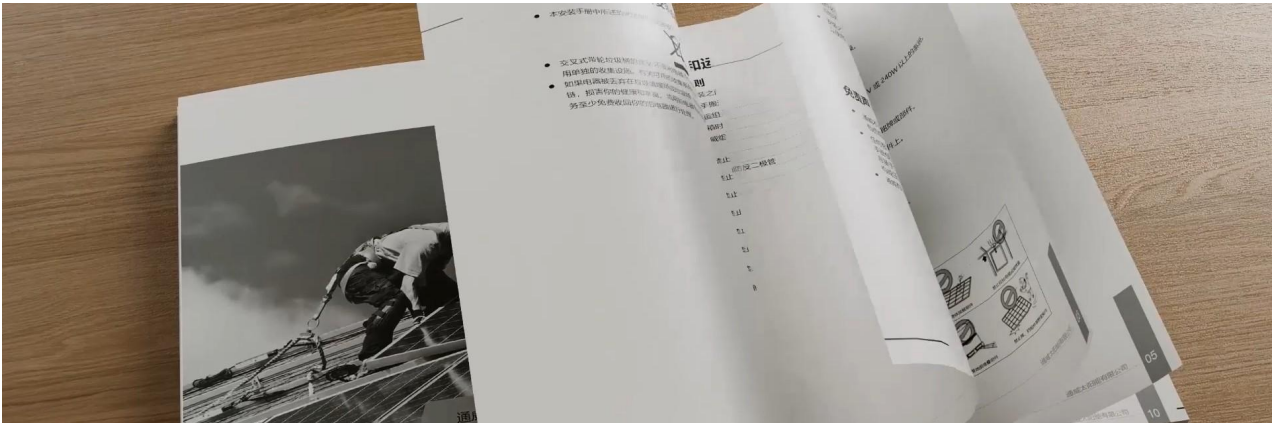

03 SAFETY & TRANSPORT

3.1 General Rules

- Keep all the Modules and electrical connectors clean and dry before installation.
- Use both hands to carry Modules. Do not overlap Modules.
- Be cautious when carrying Modules. Slip-proof gloves are necessary.
- Use supportive disassembling tools when unpacking.
- The application level of TW module is Class A, which can be used in systems operating at greater than 50 V DC or 240W.



Do not stamp on Modules or put weight on Modules.



Do not disassemble or drop Modules. Do not remove any nameplate or component of the module.



Do not use mirrors or magnifiers to concentrate sunlight onto Modules.



Do not lift the module by grasping the junction box or cable wire.



Do not use any sharp object with Modules.



Do not directly apply pressure on the glass surface or backsheet of Modules.



Do not touch the surface of the coated glass with bare hands.



Ensure all contacts and the operating environment are clean and dry.

Modules handling and installation instructions

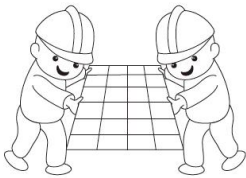

Both hands when handling Modules

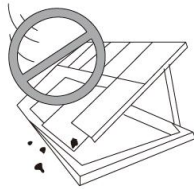

Ensure Modules are fixed properly

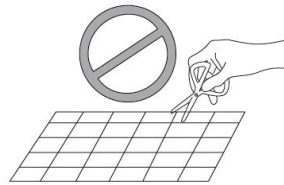

Do not use sharp objects with Modules

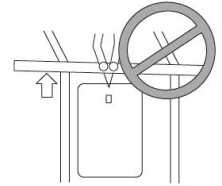

Do not pull the wiring cables or junction box

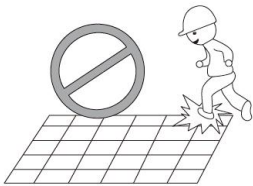

Do not stamp on Modules

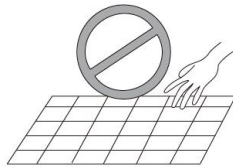

Do not touch Modules with bare or dirty hands

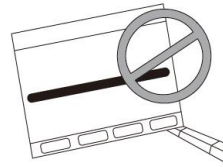

Do not pile up Modules on uneven ground



Do not drop or throw Modules

3.2 Electrical Performance Safety

- PV modules can produce DC current under sunlight. Any contact of exposed metal at module's wiring parts may result in electrical shock or burn. Any contact of 30V or larger DC Voltage can be fatal.
- In case of no connected load or external circuits, modules can still produce voltage. Please use insulation tools and wear rubber gloves when operating modules in the sunlight.
- PV modules do not have switches, operating of PV modules can only be stopped when they are kept from sunlight or covered by hard board or UV-proof materials or when the angle of the modules facing sun are placed on smooth and flat surfaces.
- To avoid electric arc and electric shock hazards, please do not break down electric connection in loaded conditions. Incorrect connections will also lead to electric arc or shock. Keep connectors dry and clean and make sure that they are in good operating condition. Do not insert other metals into the connectors or carry out electric connection by whatever means.
- Snow, water or other reflective medium in surrounding environments that intensify light re-reflection will increase output current and power. And module voltage and power will increase under low temperature condition.
- If module glass or other sealing materials are damaged, please wear personal protective equipment and then isolate modules from the circuit.
- Work only under dry conditions, and use only dry tools. Do not operate when modules are wet unless you wear personal protective equipment. Please follow the cleaning requirements in this manual when cleaning modules.
- Installation must be carried out under the guidance of a qualified electrician.
- No matter how weather condition is, personnel entering the power station shall wear safety helmet, insulating gloves and insulating shoes correctly, taking-safety protection measures.



3.3 Package labeling instructions

➤ Before the operation, it is necessary to read carefully the unpacking instruction and outer packing box instruction, and carry out the operation as instructed.

1. DO NOT expose the module to rain or moisture.



2. The Modules in the carton box are fragile. Handle with care.

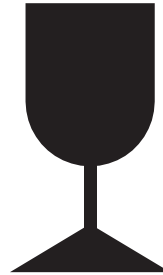

3. The package shall never be upside down during the transportation.

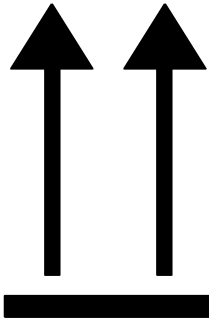

4. It is prohibited to stamp on the packing box and module.



5. During the stacking of the Modules, the outer packing box can be stacked not exceed the maximum layer allowed .(n=2 means it is allowed to stack for at most two layers.)



6. One module shall be handled by two people together.

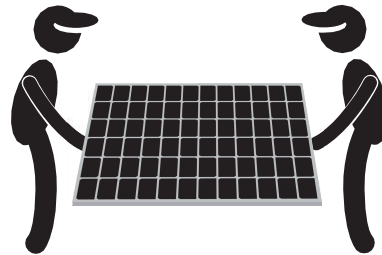

3.4 Unloading, Transportation and Storage

- When the Modules are delivered to the project site, the freight car should be ready in the flat, even and open area for parking and unloading.
- Forklift unloading: Choose the appropriate carrying forklift according to the commodity weight, unload the Modules from the freight car and place them on flat ground
- Unloading with a crane: Affix the lifting belt in the wood supporting frame buckle (Fig. 1, 2). It is allowed only to lift one pallet at a time. Before lifting, it is necessary to confirm whether the pallet and paper box are damaged and ensure that the lifting rope is robust and firm. When being lifted close to the ground, the paper box will be gently placed in a relatively flat position on the project site by two people, one on each side.

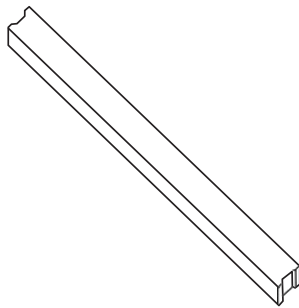

Figure.1 Wood Supporting Frame

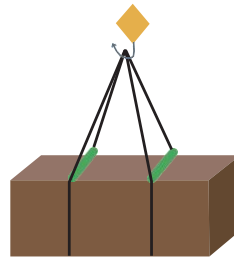

Figure.2 Lifting Schematics

- It is forbidden to stack the modules on the project site.
- During the transportation at the project site, the Modules shall not be stacked, only one layer shipping is allowed.
- Storage in the project site warehouse:
 - Storage environment requirements: Humidity < 85%, temperature -20 ~+50°C; Modules statically stacked for ≤2 layers.
 - Temporary storage at the project site: The Modules shall be stored in a dry, well-ventilated place. They shall not be stacked but shall be covered with waterproof cloth to prevent dampness in the Modules.



3.5 Unpacking description

- In the outdoor unpacking process, it is prohibited to operate in rainy conditions.
- If there is wind in the field, special attention shall be paid. Particularly in the event of heavy wind, it is recommended not to handle the module, and it is necessary to properly secure the unpacked Modules.
- The working surface shall be such that the packing box can be placed in a stable, level position, avoiding being overturned.
- During the unpacking, it is necessary to wear protective gloves, and avoid scratching the hands and leaving the fingerprints on the glass.
- In the case of operation not according to the requirements or in the case of an unskillful operation, it will result in the fall-off of the protective corner in small amounts, which will be normal. The effect of the protective corner is to reduce damage due to external force during transport, and the fall-off of the protective corner will not influence the reliability of the Modules.
- Before the unpacking, it is necessary to carefully check the product information on the carton box, and carefully read the unpacking instruction.
- Every module shall be carried by two people. When carrying the module by two people, it is prohibited to pull the junction box.

04 MECHANICAL INSTALLATION

4.1 Location Selection

- Select suitable places to install Modules.
- Install Modules at the places with sufficient sunlight and without shade at any time. If a module is shaded or even partially shaded, it will result in lower power output. A permanent or regular shade will cause module damage, which will result in the invalidity of product's limited warranty.
- Do not store, install or use Modules at the places where combustible gas is easily generated or gathering.
- Modules can be installed on land 50 to 500m away from the coastline. However, the connectors must be well protected or a dust-proof plug must be added when installing Modules within this distance. Connect the dust-proof plug immediately after removing it, and take other anti-rust measures to prevent the parts from rusting.
- Modules in the same string should be installed at the same angle. Modules installed in different angles will receive different irradiation, which will cause current different. As a result, it will decrease the operation efficiency of the system.



4.2 Installation requirements

- Ensure the module installation method and support system sufficiently robust, so that the Modules can undertake the preset loading conditions, the support installer or supplier shall provide necessary guarantee and other related certifications. The installation support system shall pass the inspection and test by the third-party test institution with the static mechanic analysis capability, and use the local national or international standards, such as DIN1055 or equivalent.
- The support structure shall be made of the durable, corrosion resistant and ultraviolet resistant materials.
- The module shall be firmly mounted on the support.
- Choose proper installation height of the photovoltaic support system, and ensure the lowest part of the module is high enough, to avoid being shaded by plant or being damaged by the flying sand. Or being covered by snow for a long time in winter.
- When the module is installed on the roof or the building, it is necessary to ensure that the roof structure is fixed firmly and will not be damaged by heavy wind or heavy snow, and the back of the module shall be well-ventilated to facilitate the cooling of the module.
- Due to the thermal expansion of physical properties of materials, the Modules are asymmetric structure, which will produce a certain degree of warping deformation at different temperatures, which does not affect the installation, use and reliability of the Modules. The minimum distance between two Modules should not be less than 10 mm.
- Ensure that the module backside will not contact the support or architectural structure even if there is the module surface is under the external pressure.
- It is required to observe the instruction guide and safety rules attached on the support.
- It is not allowed to drill the hole in the glass surface or frame of the module. Otherwise ,the guarantee will be invalidated.
- When to install the Modules on the roof, it is necessary to guarantee the roof structure is suitable for the module installation. And the installed modules should not be beyond the roof zone. Additionally, the roof area where it is penetrated by module installation shall be properly sealed to prevent the roof from water leakage.
- When the module is installed on the supporting column, it is necessary to ensure the supporting column and module installation structure is capable of withstanding the expected local wind.



4.3 Installation method

◆ Installation with the mounting clamp

Table 1 Installation Method

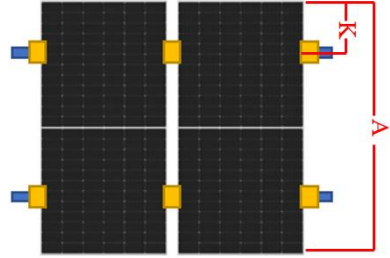
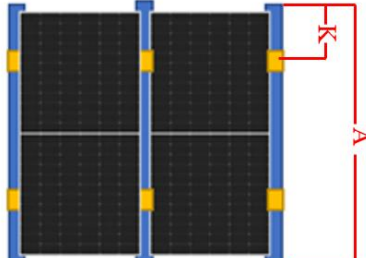
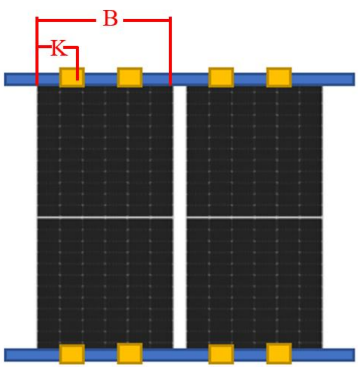
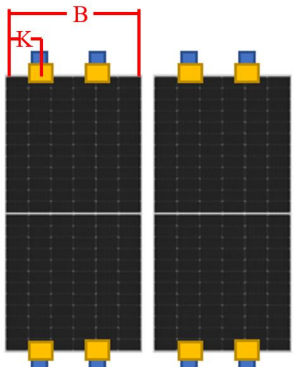
<p>Clamping on the long side</p>	<p>Installation Method A</p> 	<p>Installation Method B</p> 
<p>Clamping on the short side</p>	<p>Installation Method C</p> 	<p>Installation Method D</p> 

Note : Briquette length ≥ 50mm



Table 2 Installation method and load capacity

Classification	Installation method		method A		method B		method C		method D	
	Modules model	Height of the frame (mm)	Mounting clamp position K (mm)	Test load: front/back, (Pa)	Mounting clamp position K (mm)	Test load: front/back, (Pa)	Mounting clamp position K (mm)	Test load: front/back, (Pa)	Mounting clamp position K (mm)	Test load: front/back, (Pa)
Monofacial Module	TWMPD-54HS TWMPD-54HB TWMND-54HS TWMND-54HB	B30	A/4±50	5400/2400	200 ~ 300	3600/2400	100 ~ 240	±1600	100 ~ 240	±1600
	TWMPD-60HS TWMND-60HS	B35		5400/2400	300 ~ 400	3600/2400	100 ~ 240	±1600	100 ~ 240	±1600
	TWMPD-66HS TWMND-66HS	B35		5400/2400	--	--	0 ~ B/4	±1200 (special clamp)	150 ~ 240	±1600
	TWMPD-72HS TWMND-72HS	B30		5400/2400	--	--	--	--	--	--
		B35	5400/2400	--	--	0 ~ B/4	±1200 (special clamp)	--	--	
	TWMPD-78HS TWMND-78HS	B35	570~630	5400/2400	--	--	--	--	--	--
	TWMPF-50HS	B35	360~420	5400/2400	--	--	--	--	--	--
	TWMPF-55HS	B35	440~540	5400/2400	--	--	--	--	--	--
	TWMPF-54HS	B35	360~430	5400/2400	--	--	--	--	--	--
	TWMPF-60HS	B35	360~420	5400/2400	365~435	3600/2400	45~485	±1000	--	--
	TWMPF-66HS	B35	440~540	5400/2400 (special clamp)	--	--	--	--	--	--
	TWMNG-72HS	B35	A/4±50	5400/2400	A/4±50	5400/2400	--	--	--	--
	TWMNH-66HS	B35		5400/2400		5400/2400	--	--	--	--
Bifacial Module	TWMPD-60HD TWMND-60HD	B30	A/4±50	5400/2400	A/4±50	3600/2400	--	--	--	--
	TWMPD-66HD TWMND-66HD	B30				3600/2400	--	--	--	--
	TWMPD-72HD TWMND-72HD	B30		5400/2400	3600/2400	--	--	--	--	
		B35		5400/2400	3600/2400	--	--	--	--	
	TWMPD-78HD TWMND-78HD	B30		5400/2400	--	--	--	--	--	
		B35		5400/2400	--	--	--	--	--	
	TWMPF-50HD	B35		5400/2400	--	--	--	--	--	--
	TWMPF-55HD	B35		5400/2400	440~540	3600/2400	--	--	--	--
	TWMPF-54HD	B35		5400/2400	--	--	--	--	--	--
	TWMPF-60HD TWMHF-60HD	B35		5400/2400	360~420	3600/2400	--	--	--	--
	TWMPF-66HD TWMHF-66HD	B33		5400/2400	--	--	--	--	--	
		B35		5400/2400	440~540	3600/2400	--	--	--	
	TWMNG-54HC TWMNG-54HD	B30		5400/2400	--	--	four angles	±1200	100 ~ 240	±1600
	TWMNG-72HD	B30		5400/2400	A/4±50	3600/2400	--	--	--	--
	TWMNH-48HC TWMNH-48HD	B30		5400/2400	--	--	four angles	±1200	100 ~ 240	±1600
TWMNH-66HD	B30	5400/2400	A/4±50	3600/2400	--	--	--	--		

Note: Test load = γ (safety factors) × design load, some installation methods require special clamp, please consult technical support department of TW for special clamp structure shape

◆ Installation with the mounting hole

Table 3 Installation Method

<p>Mounting on the long side</p>	<p>Method E</p> 	<p>Method F</p> 
--	---	---

Table 4 Mounting dimension and load capacity

Classification	Modules model	Height of the frame (mm)	The mounting clamp position M(mm)	The mounting clamp position N(mm)	Installation Method E Test load: front/back (Pa)	Installation Method F Test load: front/back, (Pa)
Monofacial Module	TWMPD-54HS TWMPD-54HB TWMND-54HS TWMND-54HB	B30	990	1085	5400/2400	--
	TWMPD-60HS TWMND-60HS	B35	990	1085	5400/2400	--
			1400	1085	±2400	--
	TWMPD-66HS TWMND-66HS	B35	990	1085	±2400	--
			1400	1085	5400/2400	--
	TWMPD-72HS TWMND-72HS	B30	1400	1096	5400/2400	--
		B35	990	1085	±2400	--
			1400	1085	±5400	--
	TWMPD-78HS TWMND-78HS	B35	1200	1085	5400/2400	--
	TWMPF-50HS	B35	1400	1055	5400/2400	--
	TWMPF-55HS	B35	1400	1055	5400/2400	3600/2400
	TWMPF-54HS	B35	1400	1262	5400/2400	--
	TWMPF-60HS	B35	1400	1262	5400/2400	3600/2400
	TWMPF-66HS	B35	1400	1262	5400/2400	3600/2400
	TWMNG-72HS	B35	790	1085	±2400	±2400
			1400	1085	5400/2400	5400/2400
TWMNH-66HS	B35	790	1085	±2400	±2400	
		1400	1085	5400/2400	5400/2400	
Bifacial Module	TWMPD-60HD TWMND-60HD	B30	1200	1096	5400/2400	--
			1400	1096	3600/2400	--
	TWMPD-66HD TWMND-66HD	B30	1200	1096	3600/2400	±2400
			1400	1096	5400/2400	3600/2400
	TWMPD-72HD TWMND-72HD	B30	1200	1096	5400/2400	--
			1400	1096	3600/2400	--
		B35	1200	1096	5400/2400	±2400
			1400	1096	3600/2400	3600/2400
	TWMPD-78HD TWMND-78HD	B30	1200	1096	5400/2400	--
		B35	1200	1096	5400/2400	--
	TWMPF-50HD	B35	1400	1055	5400/2400	--
	TWMPF-55HD	B35	1400	1055	5400/2400	3600/2400
	TWMPF-54HD	B35	1400	1262	5400/2400	--
	TWMPF-60HD TWMHF-60HD	B35	1400	1262	5400/2400	3600/2400
	TWMPF-66HD TWMHF-66HD	B33	1400	1262	5400/2400	--
		B35	1400	1262	5400/2400	3600/2400
TWMNG-54HC TWMNG-54HD	B30	1100	1096	5400/2400	--	
TWMNG-72HD	B30	790	1096	±2400	±2400	
		1400	1096	5400/2400	5400/2400	
TWMNH-48HC TWMNH-48HD	B30	1100	1096	5400/2400	--	
TWMNH-66HD	B30	790	1096	±2400	±2400	
		1400	1096	5400/2400	5400/2400	

Note: Test load = γ (safety factors) × design load.

➤ **Modules can be installed and fixed using the following installation methods:**

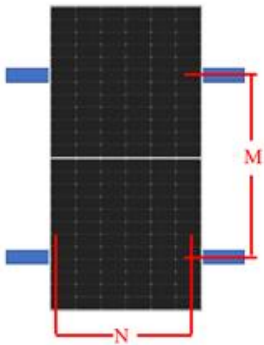
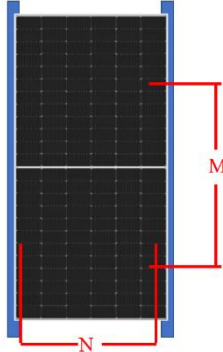
- ◇ **Bolt hole installation :** Use anti-corrosion bolts to secure with the mounting brackets through the mounting holes on the assembly frame, as shown in Figure 3;

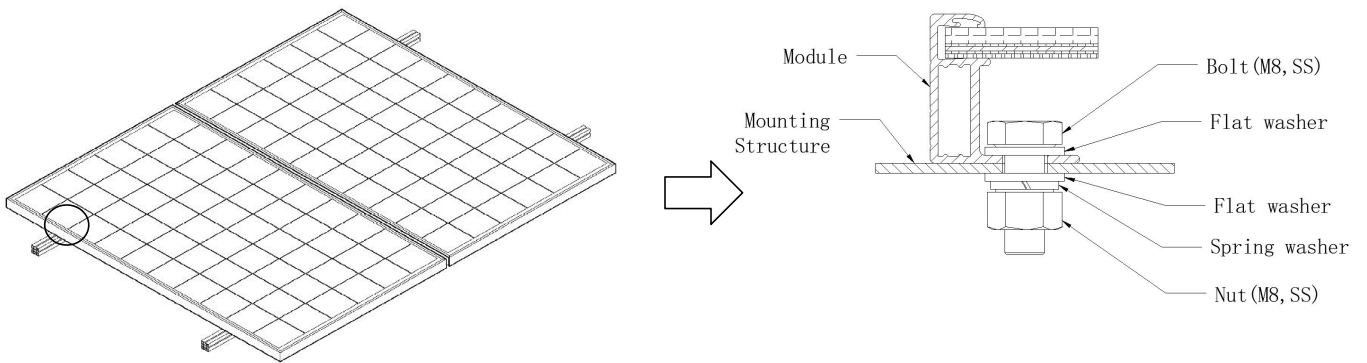

Figure 3 Bolt hole installation

➤ Recommended bolt kits are as follows:

Install fasteners	M8 bolt kits	M6 bolt kits	Notes
Bolt	M8 (full thread recommended)	M6 (full thread recommended)	The material is hot-dip galvanized or stainless steel, and the material selection is selected according to the local environment.
Washer	2pcs, thickness ≥ 1.5mm and outside diameters ≥ 16mm	2pcs, thickness ≥ 1.5mm and outside diameters = 12 ~ 16mm	
Spring Washer	8mm	6mm	
Nut	M8	M6	
Bolt tightening torque range (N·m)	16~20	8~12	

- Briquette installation: Use a suitable briquette and fix it with components and mounting brackets, as shown in Figure 4.
- ◇ The briquette must maintain at least 10mm overlap with the component frame (to ensure reliable installation of the component, the section of the briquette can be changed), and the bolt torque of the fixed briquette should be determined according to the mechanical design standards of the bolts and briquettes used by the customer, such as: M8: 16~20 N·m.

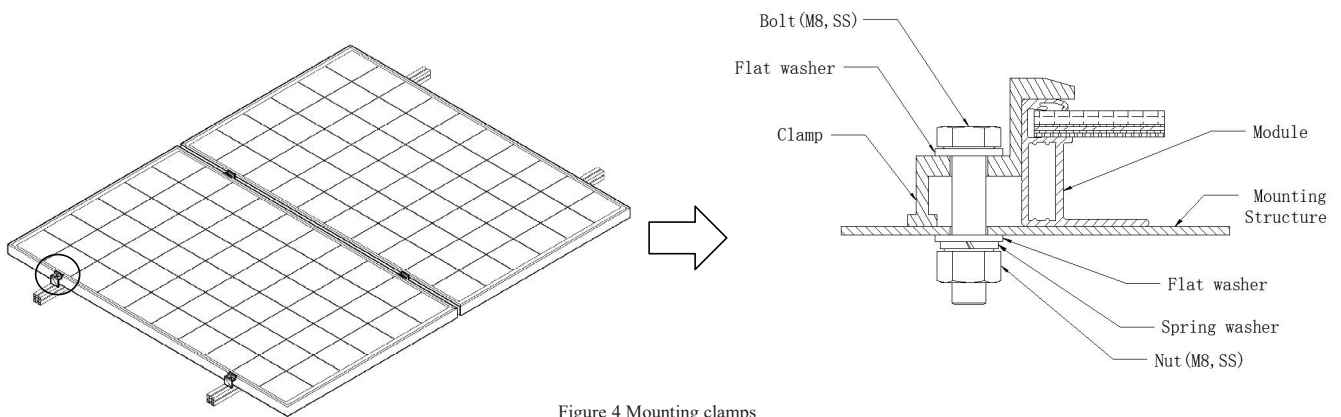

Figure 4 Mounting clamps

05 ELECTRICAL INSTALLATION

- DC power generated by the photovoltaic system can be converted into AC power and fed into the grid. Policies on connecting renewable energy system to the grid vary from region to region. Consult senior system designer before designing the system. Generally, the system installation shall be formally approved by the local public sector.

5.1 General Installation

- Installation structure should be compatible with module, in order to avoid galvanic corrosion. Any defects caused by such corrosion will void the warranty.
- The DC-side system potential of the photovoltaic array includes the practice of floating ground, positive-pole grounding and negative-pole grounding according to the system requirements; and different cell technologies have different adaptability. In a power-station project, particularly the module of the crystalline silicon photovoltaic cells, too large an absolute value of the negative to the ground might cause potential induced degradation (PID). Consequently, it is appropriate to use the negative grounding system so that the potential of the circuit is positive. Consult the inverter manufacturer for details.
- It is forbidden for non-professionals to open the lock nuts of the connector. Make sure that the connectors are clean, dry and fully connected (A click sound should be heard when fully connected), otherwise it may lead to electric arc sparks which will damage the connector or cause a fire.
- The connector given to the customer or the connector purchased by the customer and the junction box connector used in the order component must remain of the same brand and the same specification model, and connectors of different brands/specifications are not allowed to plug each other.

- Under normal conditions, a module is likely to experience conditions that produce more current and/or voltage than reported at standard test conditions. Accordingly, the values of ISC and VOC marked on the Module should be multiplied by a factor of 1.25 when determining component voltage ratings, current ratings, fuse sizes, and size of controls connected to the PV output.
- Completely cover the Modules with an opaque material to prevent electricity from being generated during disassembling the conductors.
- It is not allowed to use the Modules in different models in the same solar photovoltaic system. When the Modules are connected in series, the voltage of every string shall not be higher than the maximum voltage of the system (as shown in Figure 5). Reference equation of the maximum number of the Modules in serial connection: maximum system voltage of the module/ (1.25* open-circuit voltage), Please refer to the country's or local regulations for details.
- When connected in parallel, the current output is equal to the sum of each string's current (as shown in Figure 6). Fuse is necessary for each module string. Take reference to the local regulation. Recommended maximum parallel Modules configurations: Fuse rating/ (1.25* short-circuit current). Please refer to the country's or local regulations for details.

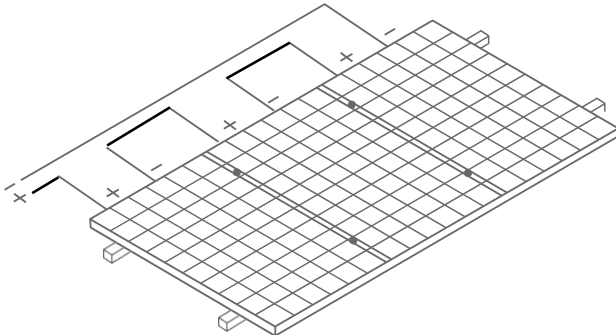

Figure 5. Connection in Series

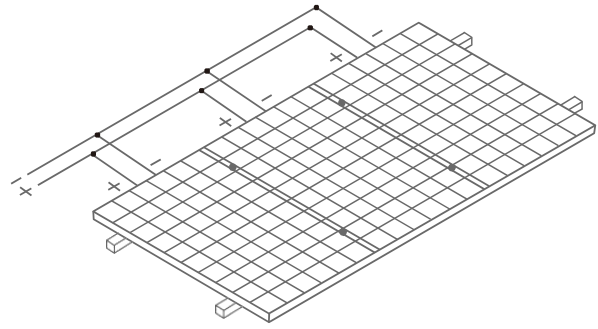

Figure 6. Connection in parallel

- Refer to the local regulations to determine the system wire size, types and temperatures.
- The cross section of the cables and the capacity of the connectors must be selected to suit the maximum system short circuit current (The recommended section area for a single piece of Module is 4 mm², and the recommended rated current for the connector is greater than 20A, Please refer to the country's or local regulations for details), otherwise the cables and connectors shall be overheated under large current. Caution: The maximal temperature of the cable is 85°C while the upper limited temperature of the connector is 105°C.
- Make sure the electric components such as the connectors and inverters are off-state during the installation. To reduce lightning damage, the loop area should be kept as small as possible when laying cables. It is recommended to use fuses in each string.

5.2 PV module layout and wiring selection instructions

- At present, the PV module arrangement is more common in single vertical row, double vertical row, single horizontal row, double horizontal row, as shown in Figure 7:

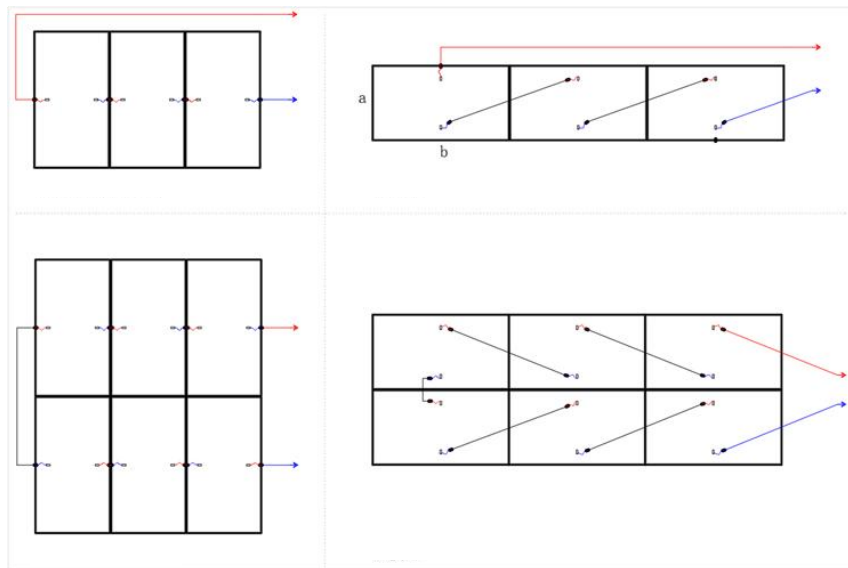

Figure.7 Common arrangement of modules

➤ The recommended cable length for different installation methods of each product is as follows:

Battery specifications	Modules model	Modules dimensions (Length*Width/mm)	Single/double vertical row Recommended cable length (mm)	Single/double horizontal row Recommended cable length (mm)
182/183.75	78	2465*1134	+ 400/-200	±1500
	72	2278*1134	+ 400/-200	±1400
	66	2093*1134	+ 400/-200	±1400
	60	1908*1134	+ 400/-200	±1200
	54	1722*1134	+ 400/-200	±1200
210	66	2384*1303	+ 400/-200	±1400
	60	2172*1303	+ 400/-200	±1400

Notes: 1. The junction box cable length of the above components contains connectors;

2. This size is a reasonable size recommended and larger than the recommended size does not affect the installation.

06 Grounding

6.1 Grounding by cable

➤ The grounding bolts must be made of stainless steel and be used in the specified grounding holes. First, make the stainless steel bolt pass through the spring washer, cup washer, flat washer, and star washer, and then insert through the grounding hole, flat washer and spring washer on the frame. Finally, tighten with a nut. Caution: The upper limited temperature of the conductor is 85°C. As for the installation, refer to Figure 8.

6.2 Grounding by lugs

- All the module frames and mounting structures shall be grounded according to regional and national electricity regulations. Use recommended hardware to connect grounding cables and fasten to the Module frames.
- While using the metal structure, make sure the surface of the system have been electroplated to keep a good conducting circuit.
- Use suitable grounding conductors to connect the Module frame to the mounting structure. This can achieve proper grounding effects.
- First, peel the grounding cable to a proper length without damage to the metal core. Then insert the peeled cable into the lug, tighten the screw. As shown in Figure 9, connect the lug to the aluminum frame with stainless steel bolts and connection components.

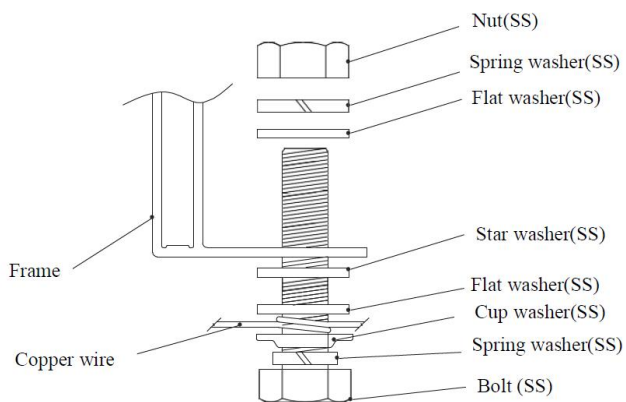

Figure 7

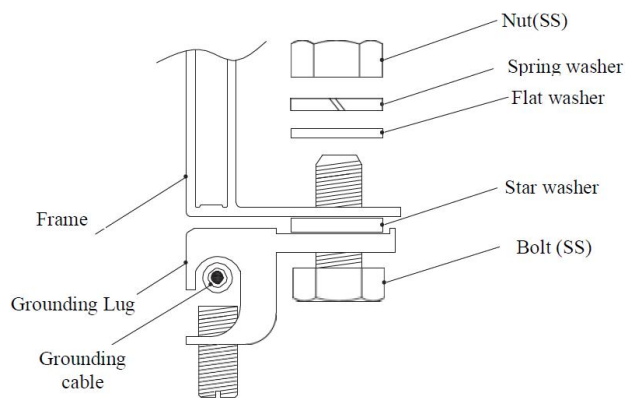

Figure 8

07 BYPASS DIODES AND BLOCK DIODES

- In a system with two or more Modules connected in series, if part of a Module is shaded while the other part is exposed to the sun, a very high reverse current will go through the cells which have been partly or entirely covered and it will cause overheat on the cells, which may damage the Module. Using bypass diodes can protect Modules from this kind of risk. There are bypass diodes in junction boxes, which can reduce the effects of partial shadows. Do not privately disassemble the junction box to replace the diodes, even when the diodes are broken. This should be processed by the professionals.
- In a system with batteries, if the controller doesn't have the function of backswing protection, block diodes installed between the battery and the Module can prevent the reverse current from damaging the Module.

08 MAINTENANCE

- **Normally, the Modules do not need repair. Follow the maintenance methods below to ensure the best performance of the Modules:**
 - ◇ In most conditions, the normal rainwater can keep the module glass clean. Clean the glass surfaces with wet soft sponge or cloth if necessary. Use mild non-abrasive cleaning agent to remove stubborn dirt.
 - ◇ Do not try to clean a Module with broken glass or perforated backsheet. It will cause serious electrical shock. Take a regular inspection on grounding, mechanical and electrical connections every 6 months. Make sure all the Module connectors are connected, clean and without damage or corrosion.
 - ◇ When disassembling the connectors, must make sure all the components are working well; otherwise the connector's shall be replaced. Damage on the connector will cause electronic leakage. The tightening torque of the nut should be $1.5 \text{ N} \cdot \text{m} - 3 \text{ N} \cdot \text{m}$.
 - ◇ Use opaque material to completely cover the Modules during repair to avoid electric shock. When exposed to the sunshine, the Modules will produce high voltage. The repair work must be carried out by professionals.



**Warning: Shut down the system before any electric repair.
Improper maintenance may cause electric shock or fire**



Customer Service Number: 4000566888

After-sales E-mail: twcustomerservice01@tongwei.com